

Installation Instructions



Surface Fixed
Flat Pack Harmony
Page 1 of 2



1. Unpack frame 3no.

2. Lay packaging out on floor or assemble on non-abrasive surface to prevent marking of polished stainless steel.

3. Align holes on legs (opposite end to polished domes) and secure in place using 3no. M10 x 200mm threaded bar and 6no. M10 nuts provided
Tools required 2no. 17mm metric spanner/wrench ($1\frac{11}{16}$ inch or alternatively using adjustable wrench)

4. Invert assembled frame so domed ends face upwards.

5. Insert M8x60mm Security screws into pre drilled holes in frame using TX40 bit.

6. Attach Notes and Surface Plate to Harmony Frame. (See Assembly Guide Sheet)

7. Locate Harmony in desired location and mark holes to fix to desired surface.

8. Fix Surface Plate to level surface using Coachscrews, Rawlbolts, chemical anchors or similar as deemed appropriate by Installer.

(It is your responsibility to ensure that the existing surface is suitable to receive the appropriate fixing)

9. Make sure all fixings are covered and secure using cover caps provided

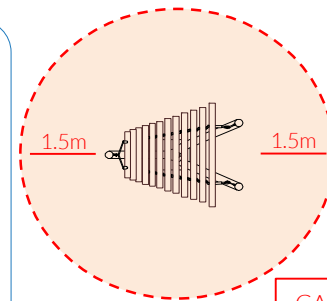

Install Instrument with 1.5m free space (from widest point) around it.

CAUTION:
Harmony surface can get hot in direct sunlight, if possible install in shaded areas.

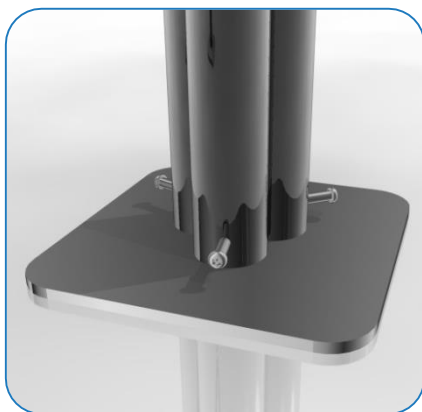

1385mm

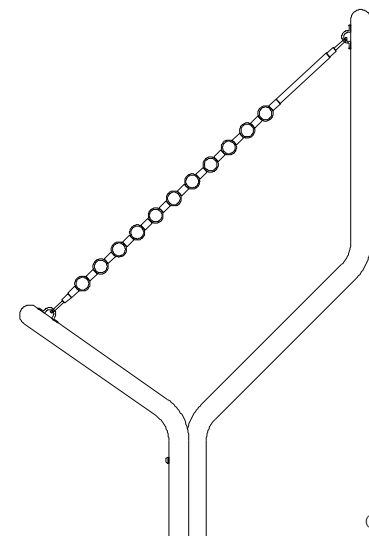

Ground Surface

Weight of heaviest part 16kg (Harmony Frame)



Pair Small Red Beaters X1

Surface Fix Components:



Ground Anchors not supplied

20 Kg



BSEN 1176

Assembly Guide PPHARM





Surface Fixed
Harmony Flat Pack
Page 2 of 2



Instrument Components:



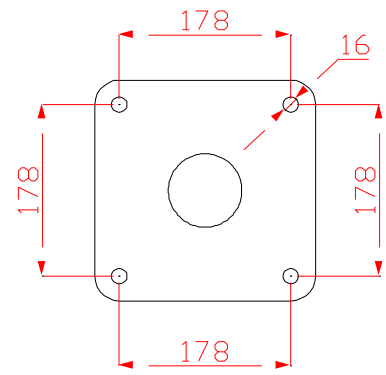
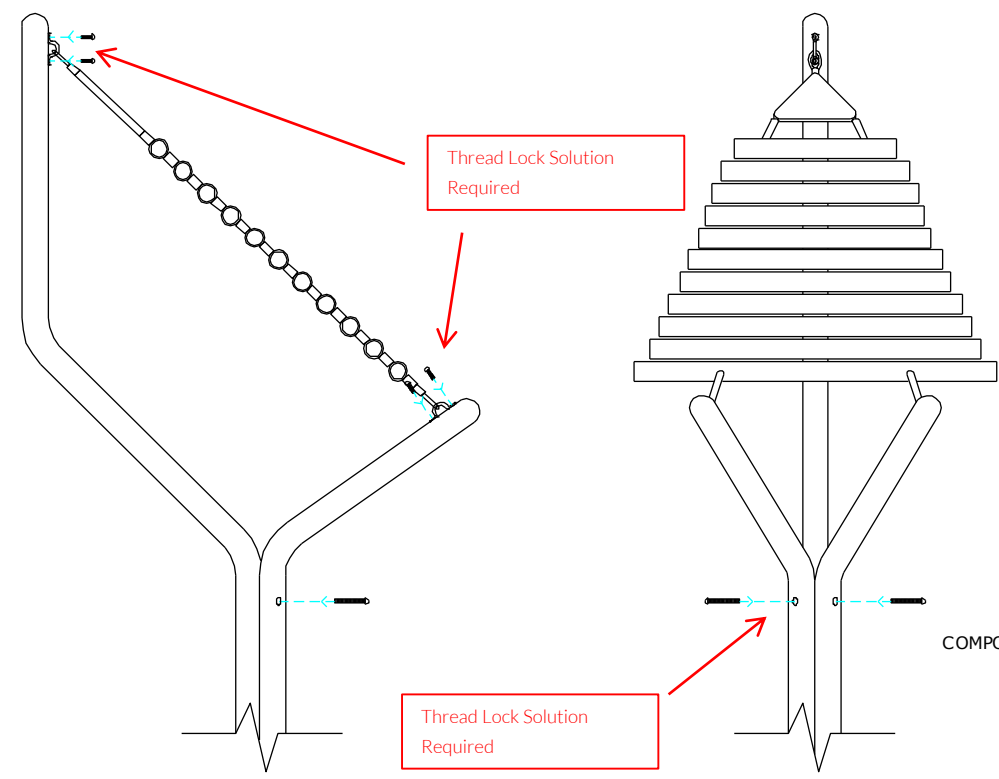

-  x6
M6x20 Security Screw
-  x3
M6 Saddle Strap

Tools:

-  x1
TX 30 Driver Bit
-  x1
TX 40 Driver Bit



COMPONENTS LIST:

-  Saddle Strap X3
-  M6x20 Pin torx X6
-  M8x60 Pin torx X2
-  M8x25 Pin torx X3
-  2 Part Cover Cap X8

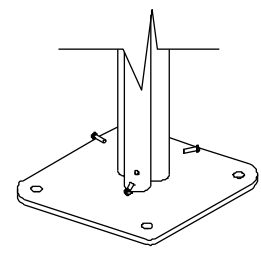

Locate the Surface fix Plate into the leg of the instrument.

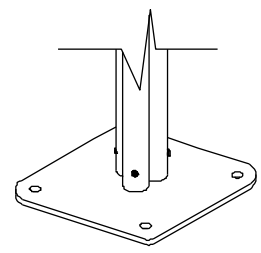

Fix instrument to Surface fix plate using M8x25 Screws and use **thread locking solution** to prevent fixings working loose.

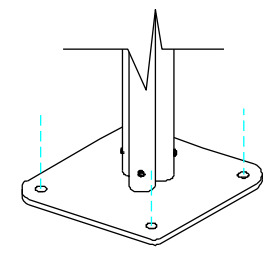

Fix Surface Plate to the ground surface **Ground Anchors Not provided** cover fixings with caps provided

CAUTION:
Harmony surface can get hot in direct sunlight, if possible install in shaded areas.

Thread Lock Solution Required

Pair Small Red Beaters X1

Surface Fix Components:

-  x2
-  x3
-  x4

Ground Anchors not supplied

20 Kg