

Surfacing Detail

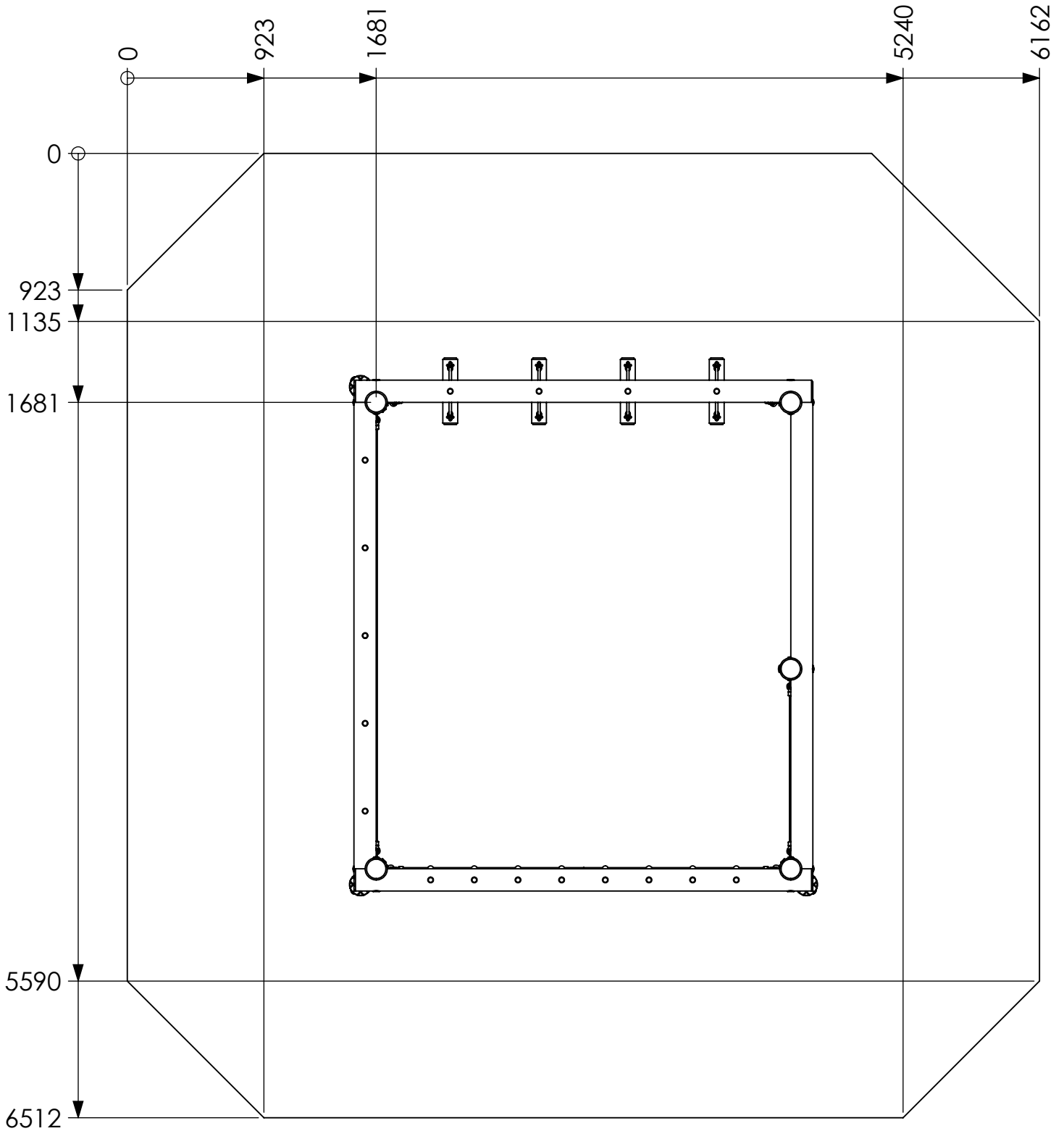

FFH: 1.25m
Area: 38.2m²

This equipment for play areas is manufactured following the codes & practice outlined in the British and European standards and in so doing meets the requirements of BSEN 1176 (general safety and test methods).